

Series	RG Series
Block Type	Square Type
Model Size	35
Load Type	Super heavy Load
Block Mounting	Mounting from Top
Block	Standard Block
Preload Class	Medium Preload (0.07 ~ 0.09C)
Precision Code	H
Dust Protection	Standard protection (End seal and bottom seal)

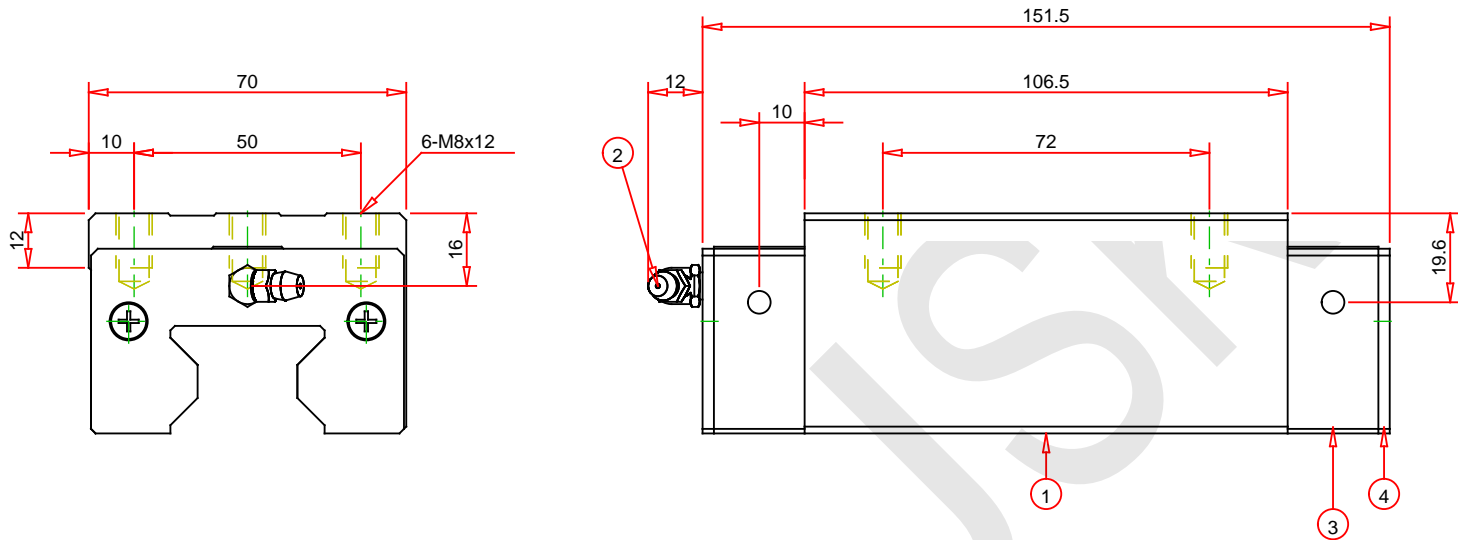

4	End Seal	2
3	End Cap	2
2	Grease Nipple	1
1	Block	1
No.	Part Name	Qty

Notes : - Drawing not to scale
- Dimensions subject to change without notice

Part No. :

RGH35HAZAH

Description :

RG Series - Interchangeable Type - Block

HIWIN
Motion Control and System Technology

Hiwin Technologies Corp.

Address : No. 7, Jingke Road
Taichung Precision Machinery Park
Taichung 40852, Taiwan
Tel. : +86 25 68021803
Email : sales@njskt.com
Web : www.njskt.com