

Series	HG Series
Block Type	Flange Type
Model Size	35
Load Type	Heavy Load
Block Mounting	Mounting from Top
Block	Standard Block
Preload Class	Medium Preload (0.05 ~ 0.07C)
Precision Code	C
Dust Protection	Standard protection (End seal and bottom seal)

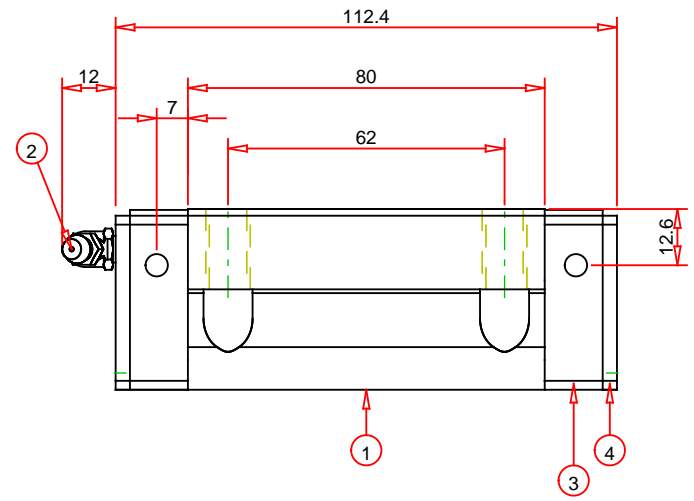
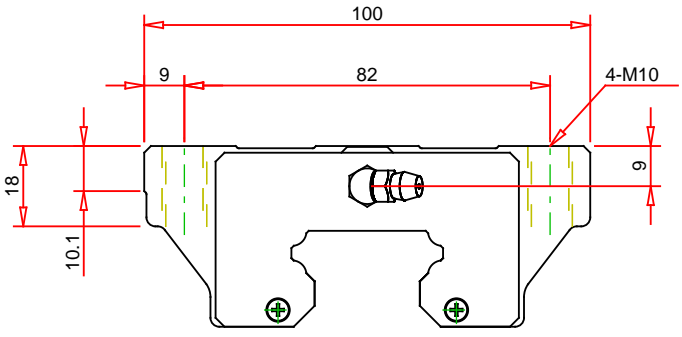

4	End Seal	2
3	End Cap	2
2	Grease Nipple	1
1	Block	1
No.	Part Name	Qty

Notes :  
 - Drawing not to scale  
 - Dimensions subject to change without notice

Part No. :  
 HGW35CAZAC

Description :  
 HG Series - Interchangeable Type - Block

**HIWIN**  
 Motion Control and System Technology

**Hiwin Technologies Corp.**

Address : No. 7, Jingke Road  
 Taichung Precision Machinery Park  
 Taichung 40852, Taiwan

Tel. : +86 25 68021803  
 Email : sales@njskt.com  
 Web : www.njskt.com