

Series	EG Series
Block Type	Square Type
Model Size	20
Load Type	Heavy Load
Block Mounting	Mounting from Top
Block	Standard Block
Preload Class	Light Preload (0 ~ 0.02C)
Precision Code	C
Dust Protection	Standard protection (End seal and bottom seal)

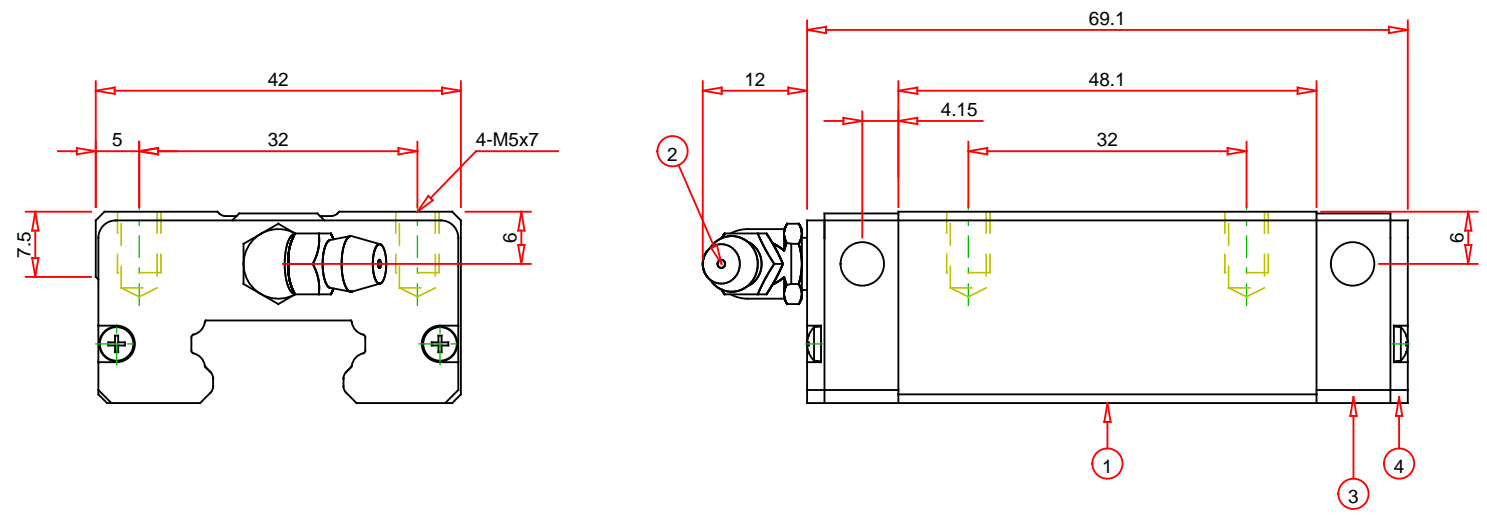

7	0	1
4	End Seal	2
3	End Cap	2
2	Grease Nipple	1
1	Block	1
No.	Part Name	Qty

Notes :
 - Drawing not to scale
 - Dimensions subject to change without notice

Part No. :
 EGH20CAZ0C

Description :
 EG Series - Interchangeable Type - Block

HIWIN
 Motion Control and System Technology

Hiwin Technologies Corp.

Address : No. 7, Jingke Road
 Taichung Precision Machinery Park
 Taichung 40852, Taiwan
 Tel. : +86 25 68021803
 Email : sales@njskt.com
 Web : www.njskt.com